

Instrukcja Montażu

Szafa 1D 180/50 1pd

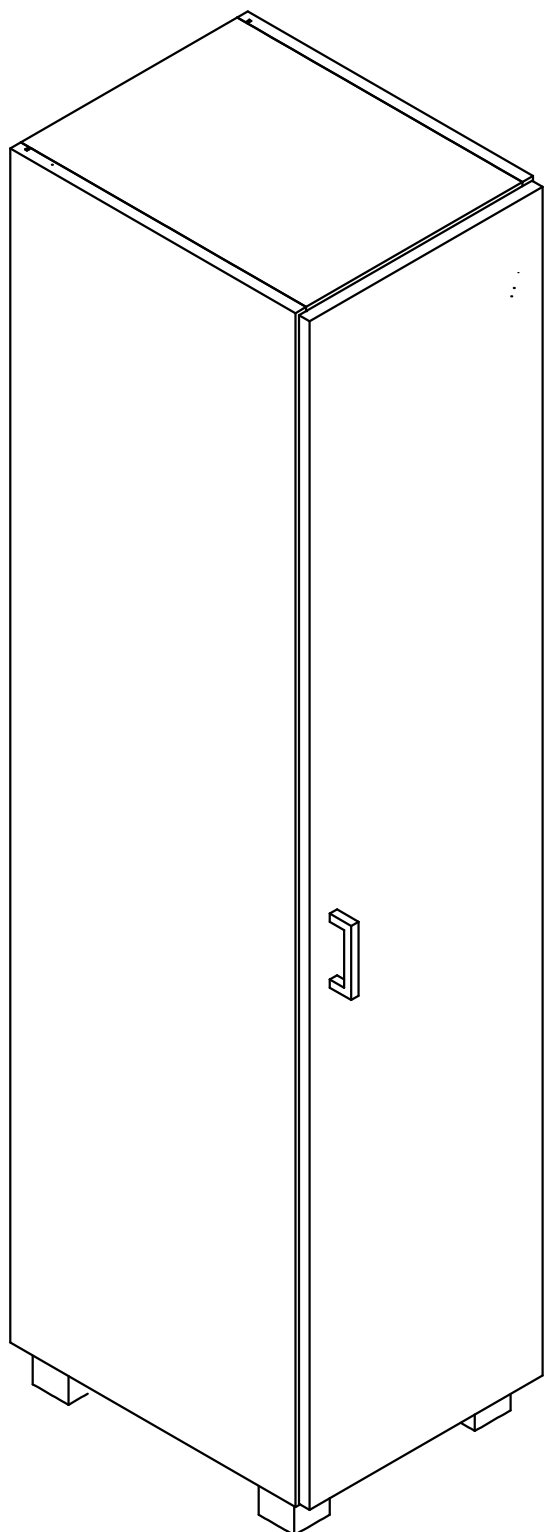

Nr.	Nazwa	Opis	Ilość
1	Kołek drewniany 8x36	B6	12
2	Trzpień mimośrodowy	K1	16
3	Mimośród Ø15x12	K5	16
4	Zaślepka mimośrodowa Ø20	K1z	16
5	Rozeta 25 [mm]	D1	2
6	Drażek 25 [mm]	D2	1
7	Noga meblowa	NM1	4
8	Zawias prosty	C3	2
9	Wkręt 4x16 łeb stożkowy	G4	24
10	Wkręt 4x20 łeb stożkowy	G5	6
11	Uchwyt meblowy 96	H1	1

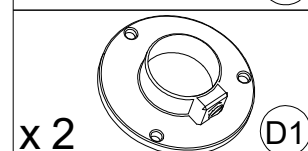
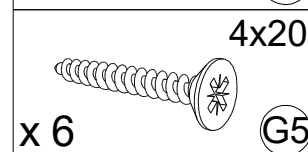
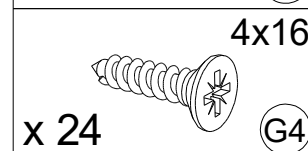
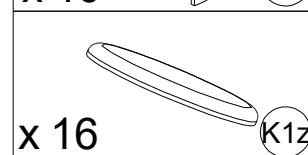
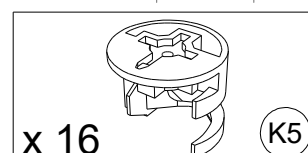
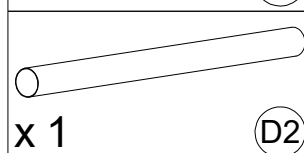
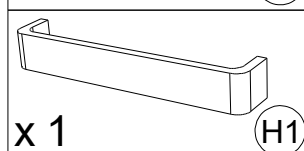
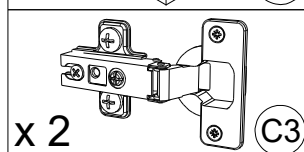
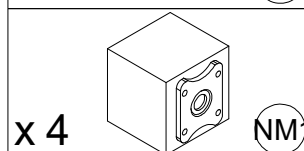
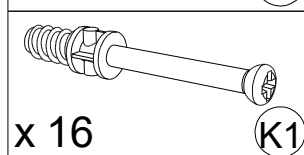
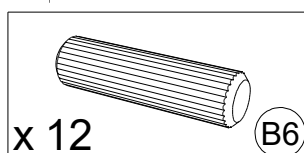

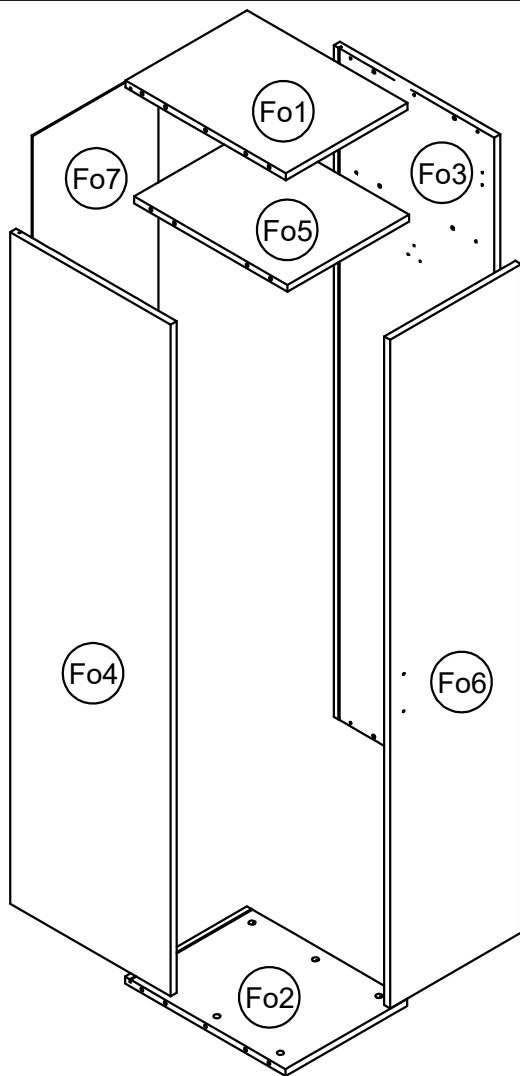

Nr.	Nazwa części	Ilość	Dłg.	Sze	Gb
Fo1	Wieniec Góra	1	480	364	18
Fo2	Wieniec Dół	1	480	364	18
Fo3	Bok Prawy	1	1740	480	18
Fo4	Bok Lewy	1	1740	480	18
Fo5	Półka Mocowan	1	458	364	18
Fo6	Front	1	1732	392	18
Fo7	Plecy	1	1716	376	3

