

Instrukcja Montażu

Szafa 2D 200/50 5p_d2p

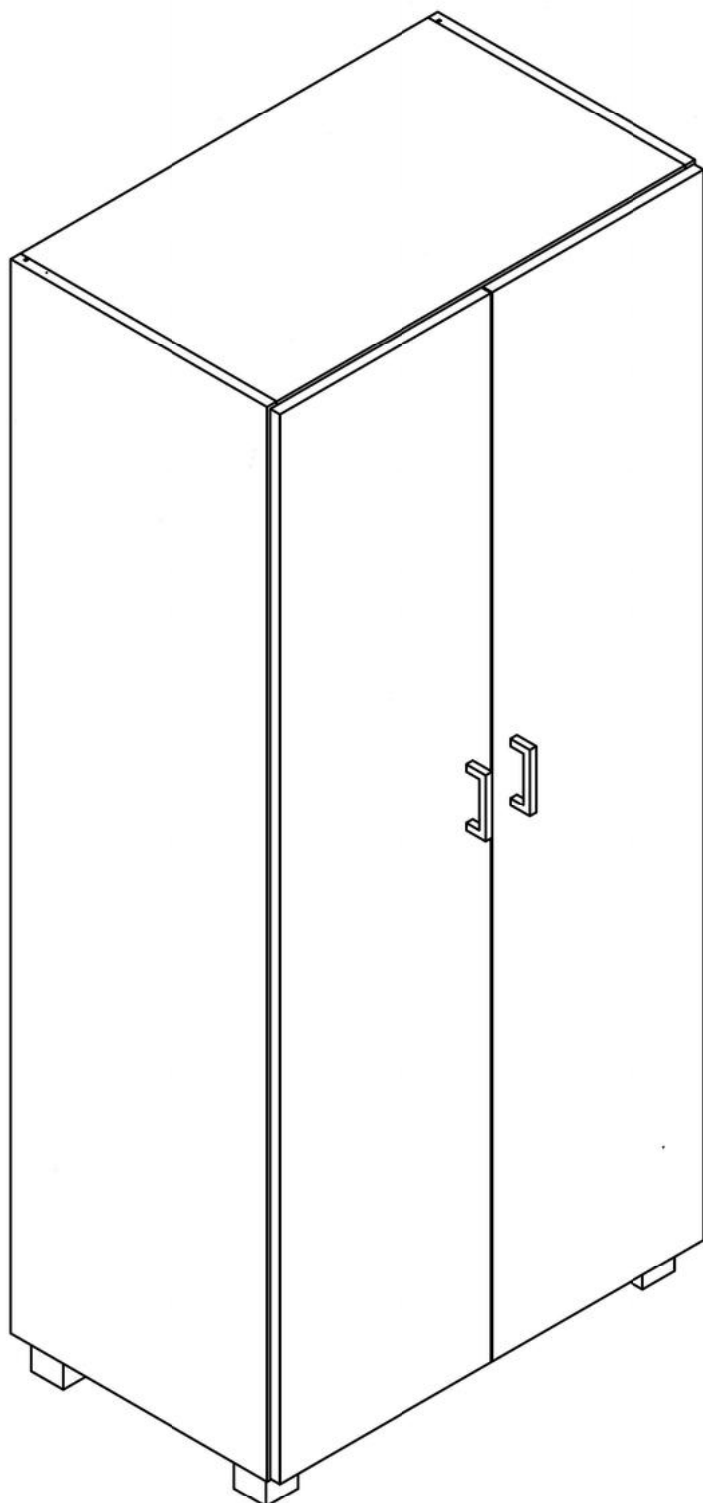

Nr.	Nazwa	Opis	Ilość
1	Kołek drewniany 8x36	B6	20
2	Trzpień mimośrodowy	K1	26
3	Mimośród Ø15x12	K5	26
4	Zaślepka mimośrodu Ø20	K1z	26
5	Noga meblowa	NM1	4
6	Zawias prosty	C3	6
7	Wkręt 4x16 łeb stożkowy	G4	40
8	Wkręt 4x20 łeb stożkowy	G5	6
9	Uchwyt meblowy 96	H1	2
10	Podpórka kołkowa Ø5	F2	20
11	Rozeta 25 [mm]	D1	2
12	Drażek 25 [mm]	D2	1

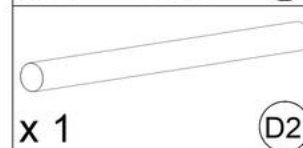
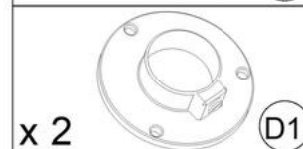
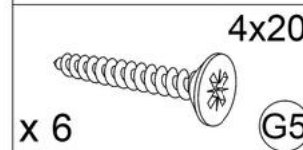
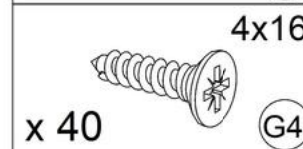
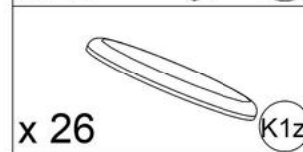
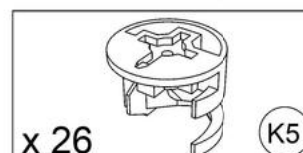
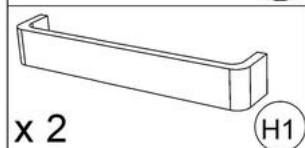
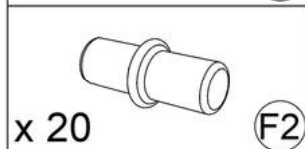
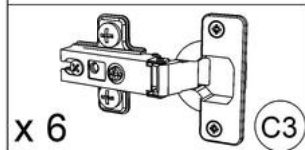
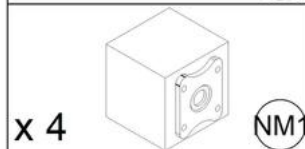
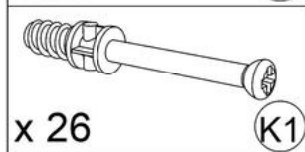
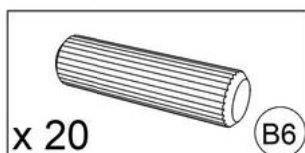

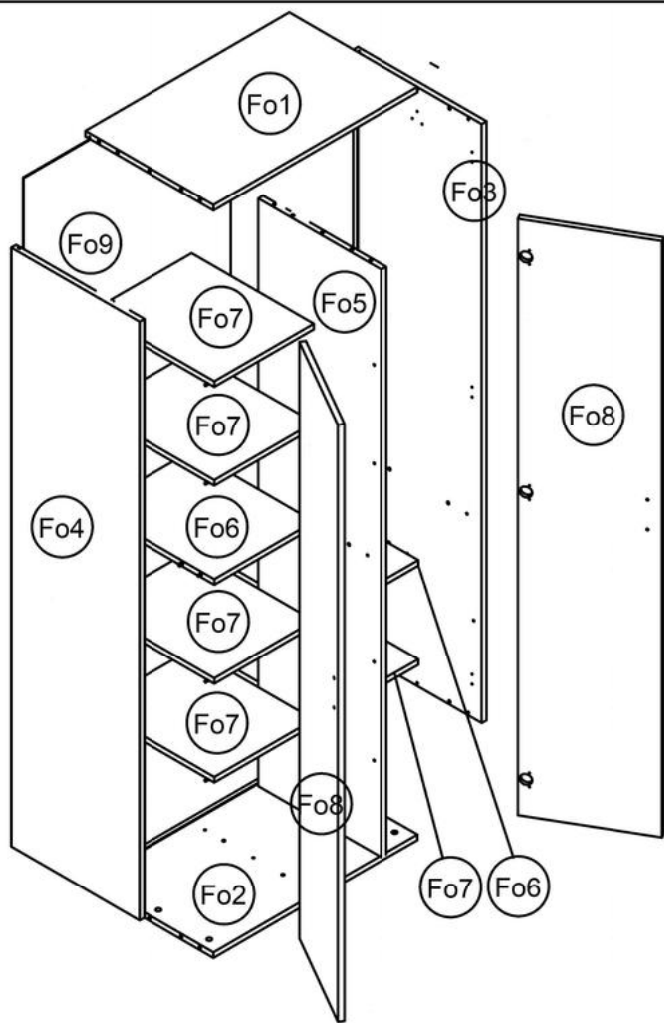

Nr.	Nazwa części	Ilość	Dłg.	Szer	Gb.
Fo1	Wieniec Góra	1	764	480	18
Fo2	Wieniec Dół	1	764	480	18
Fo3	Bok Prawy	1	1940	480	18
Fo4	Bok Lewy	1	1940	480	18
Fo5	Podział Pionowy	1	1904	461	18
Fo6	Półka Mocowana	2	458	373	18
Fo7	Półka Luźna	5	458	373	18
Fo8	Front	2	1932	395	18
Fo9	Plecy	2	1916	387	3

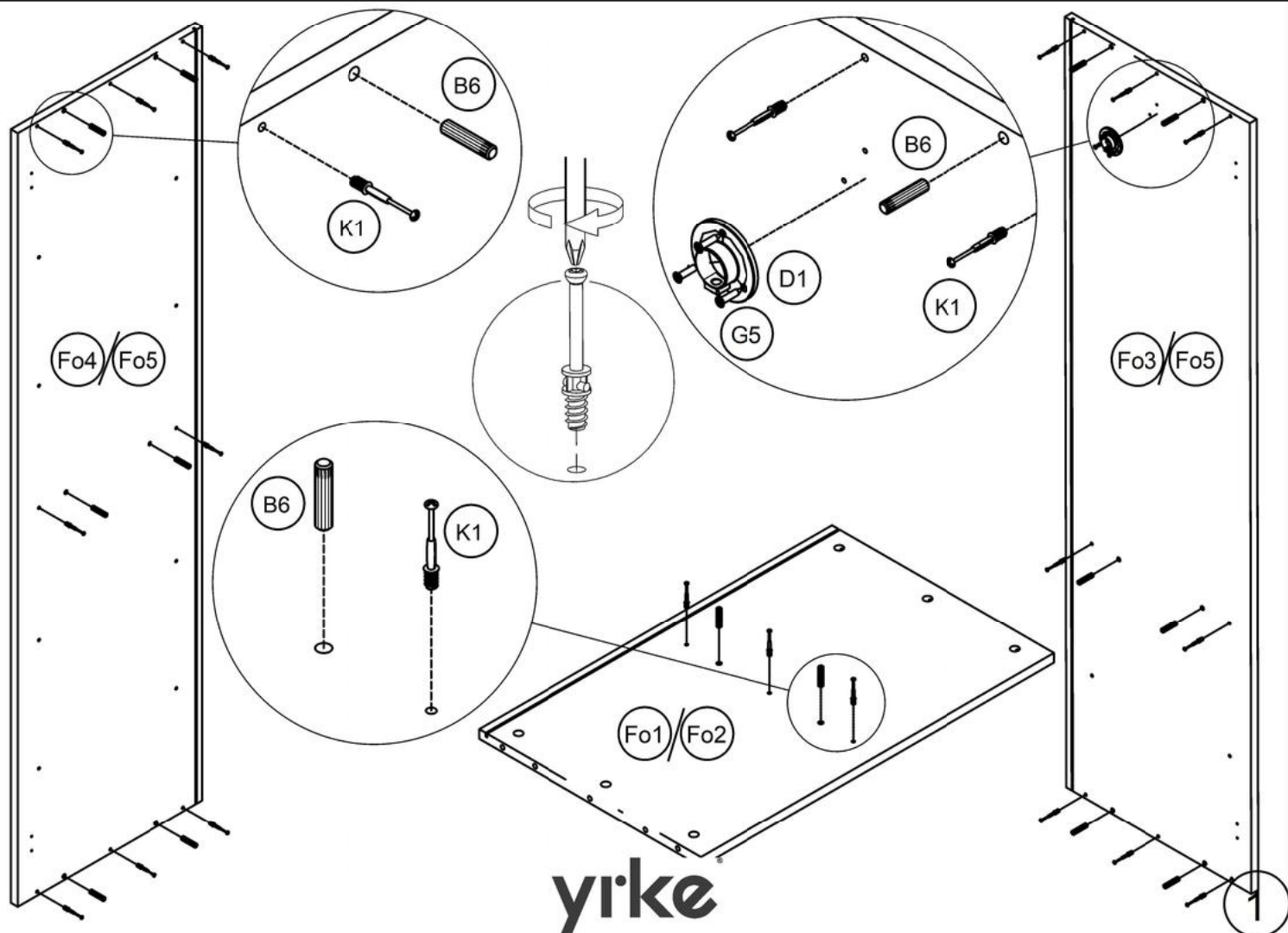

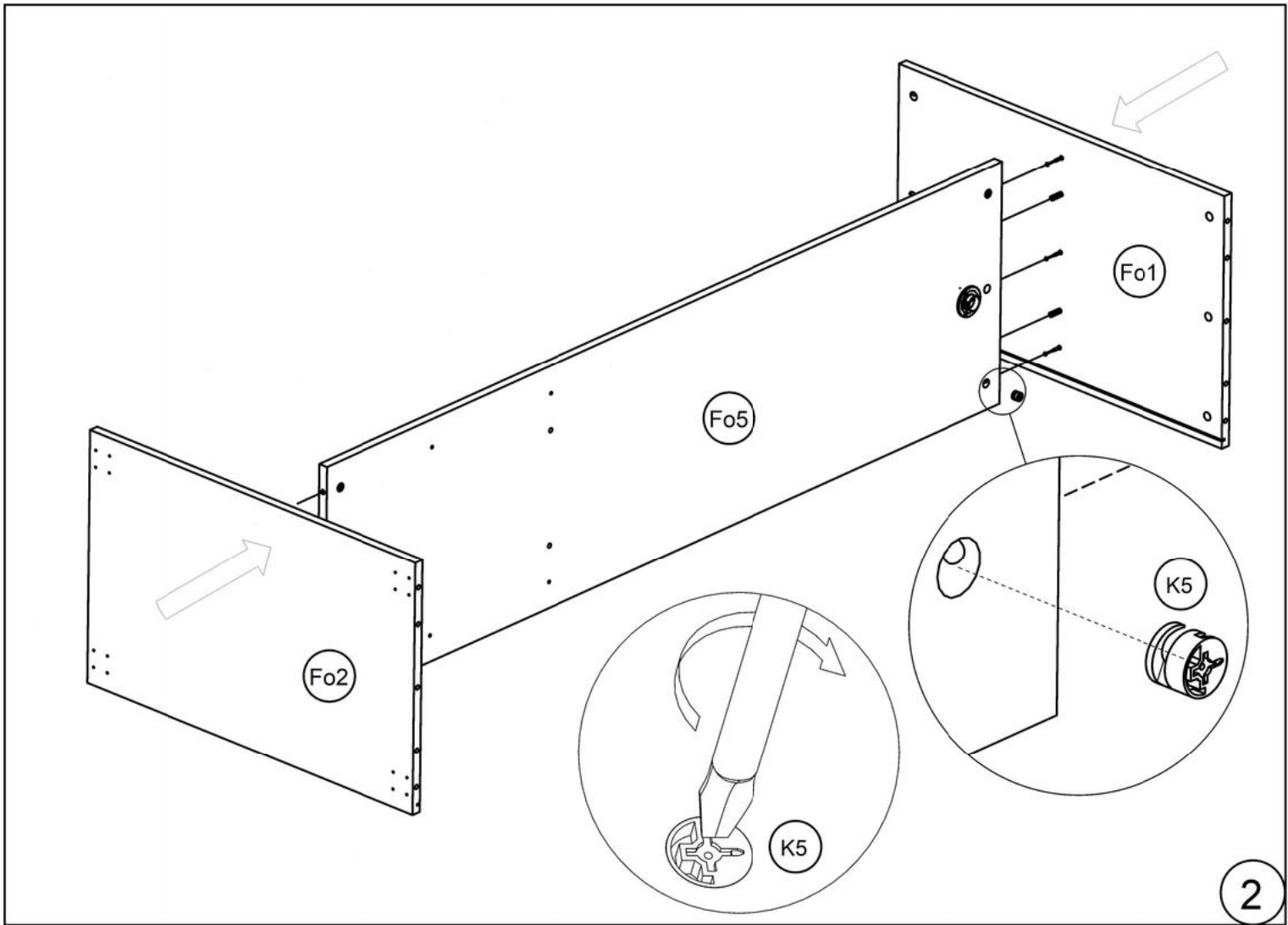

2

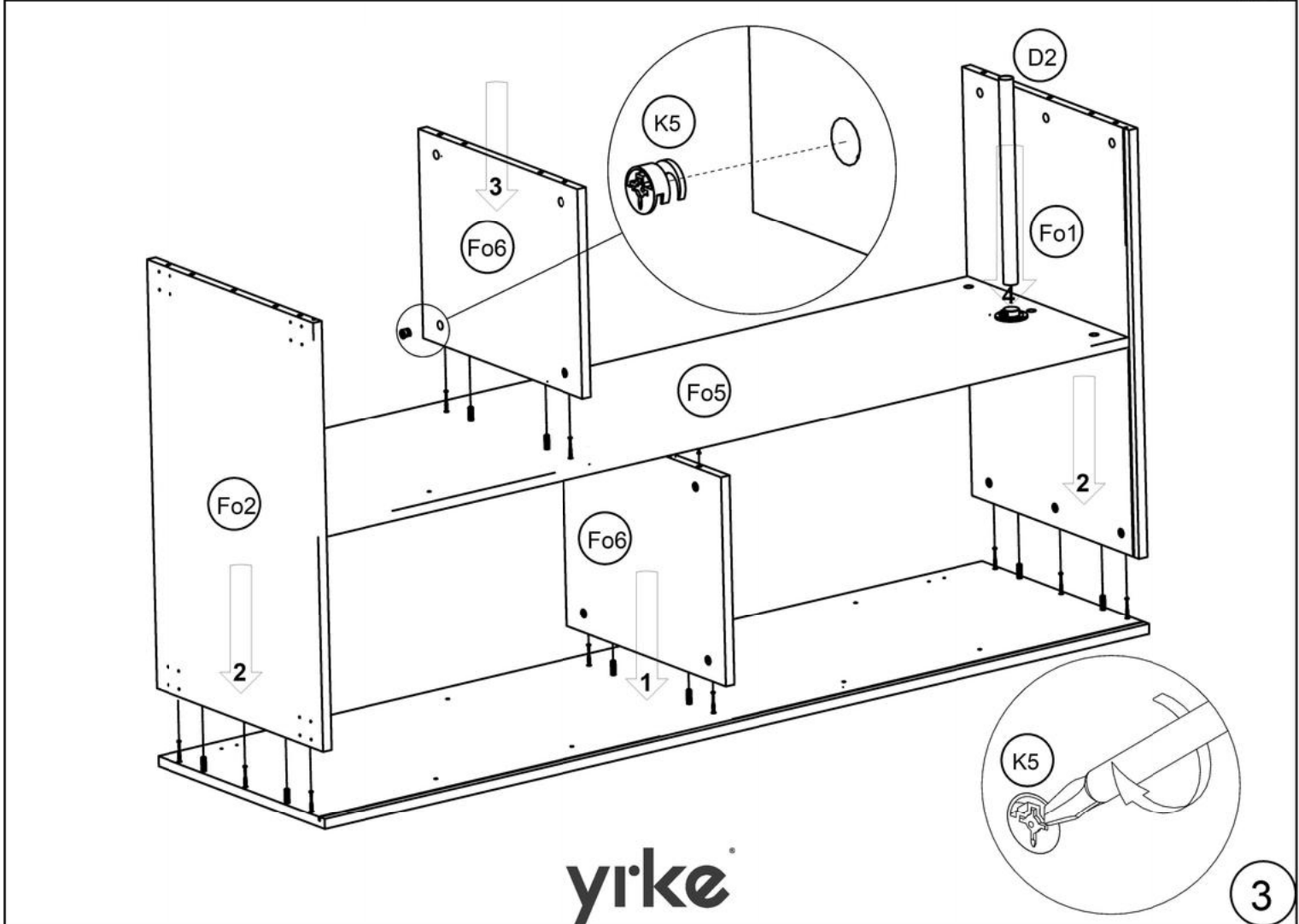

3

yirke

