

# Szafa biurowa na segregatory podwójna (kolekcja biurowa) - Instrukcja Montażu

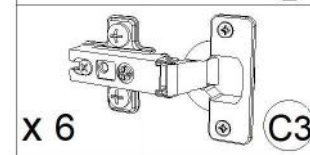

Nr	Nazwa części	Opis	Ilość
1	Kolek drewniany 8x36	B6	12
2	Trzpień mimośrodowy	K1	16
3	Mimośód Ø15x12	K5	16
4	Zaślepka mimośrodu Ø20	K1z	16
5	Noga meblowa	NM1	4
6	Podpórka półki Ø5	F2	12
7	Zawias prosty	C3	6
8	Wkręt 4x16 łeb stożkowy	G4	40
9	Uchwyt	H1	2

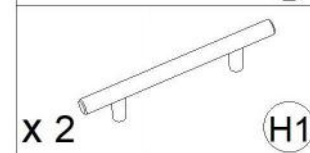
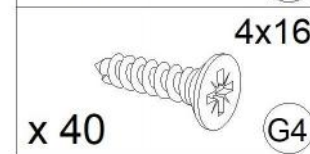
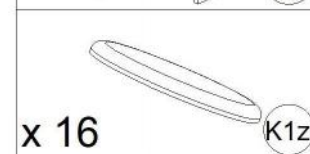
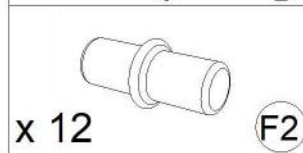
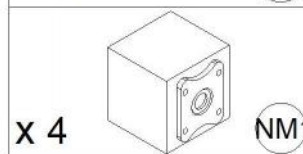
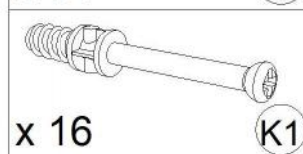
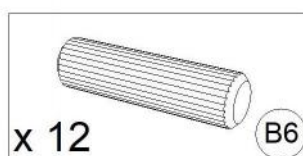
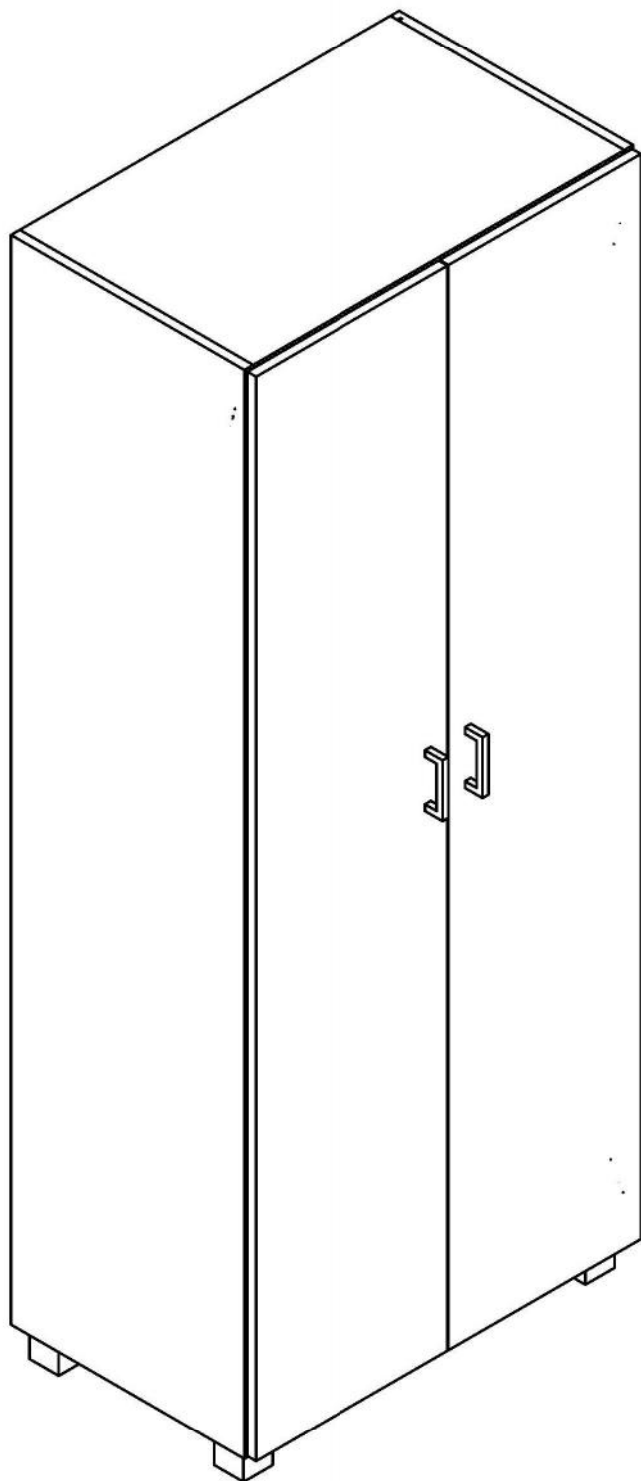
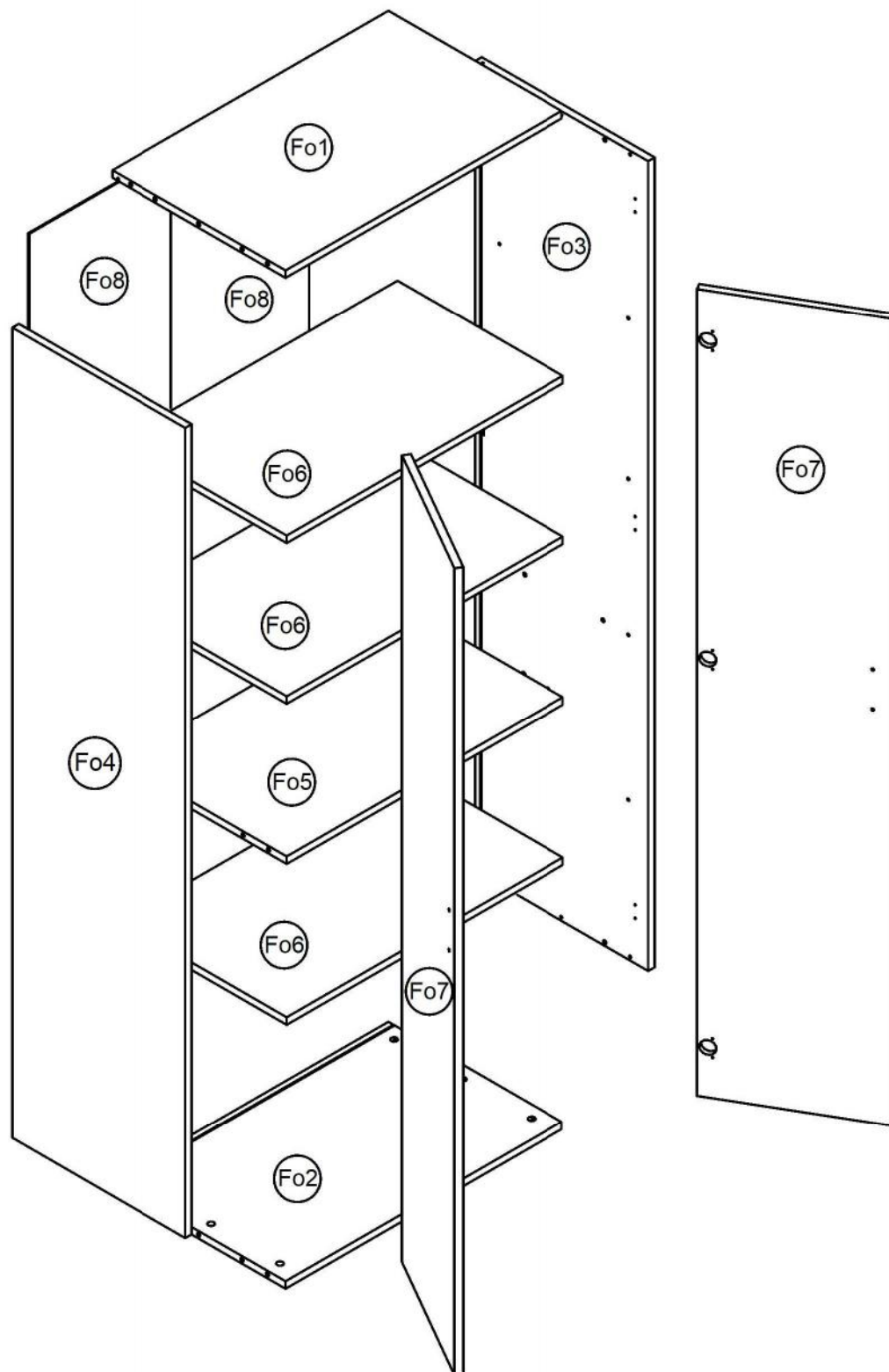

Nr.	Nazwa części	Ilość	Dłg.	Szer	Gb.
Fo1	Wieniec Góra	1	764	380	18
Fo2	Wieniec Dół	1	764	380	18
Fo3	Bok Prawy	1	1940	380	18
Fo4	Bok Lewy	1	1940	380	18
Fo5	Półka Mocowana	1	764	364	18
Fo6	Półka Luźna	3	764	364	18
Fo7	Front	2	1932	395	18
Fo8	Plecy	2	1916	387	3

