

Instrukcja Montażu

Regał na stelażu 180/50 5p

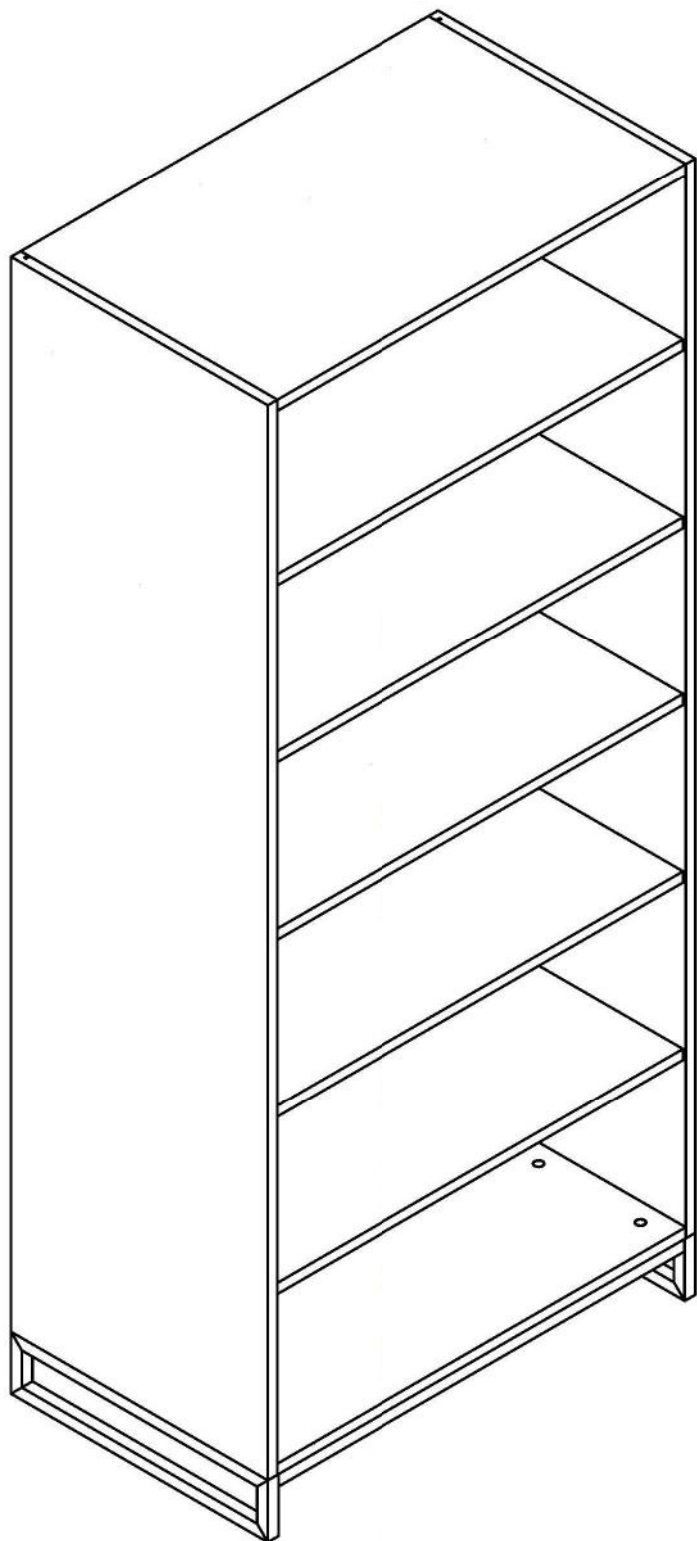

Nr.	Nazwa	Opis	Ilość
1	Kołek drewniany 8x36	B6	16
2	Trzpień mimośrodowy	K1	20
3	Mimośród Ø15x12	K5	20
4	Zaślepka mimośrodu Ø20	K1z	20
5	Wkręt 4x16 łeb z podkładką	G7	6
6	Podpórka półki Ø5	F2	12

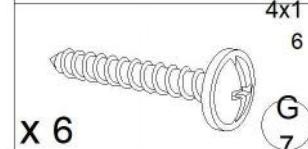
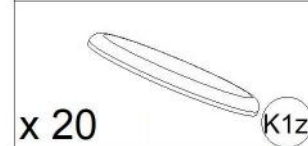
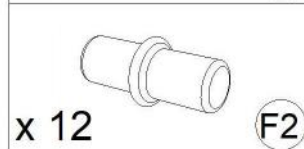
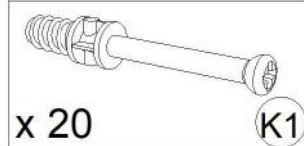
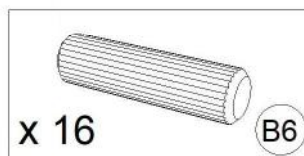

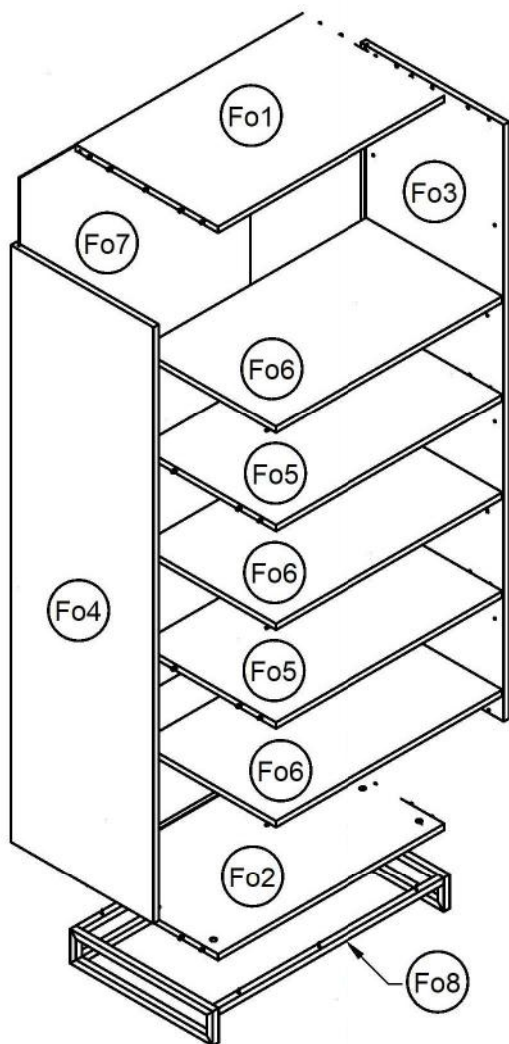

Nr.	Nazwa części	Ilość	Dłg.	Sze	Gb
Fo1	Wieniec Góra	1	764	480	18
Fo2	Wieniec Dół	1	764	480	18
Fo3	Bok Prawy	1	1740	480	18
Fo4	Bok Lewy	1	1740	480	18
Fo5	Półka Mocowan	2	764	458	18
Fo6	Półka Luźna	3	764	458	18
Fo7	Plecy	1	1716	387	3
Fo8	Stelaż	1			

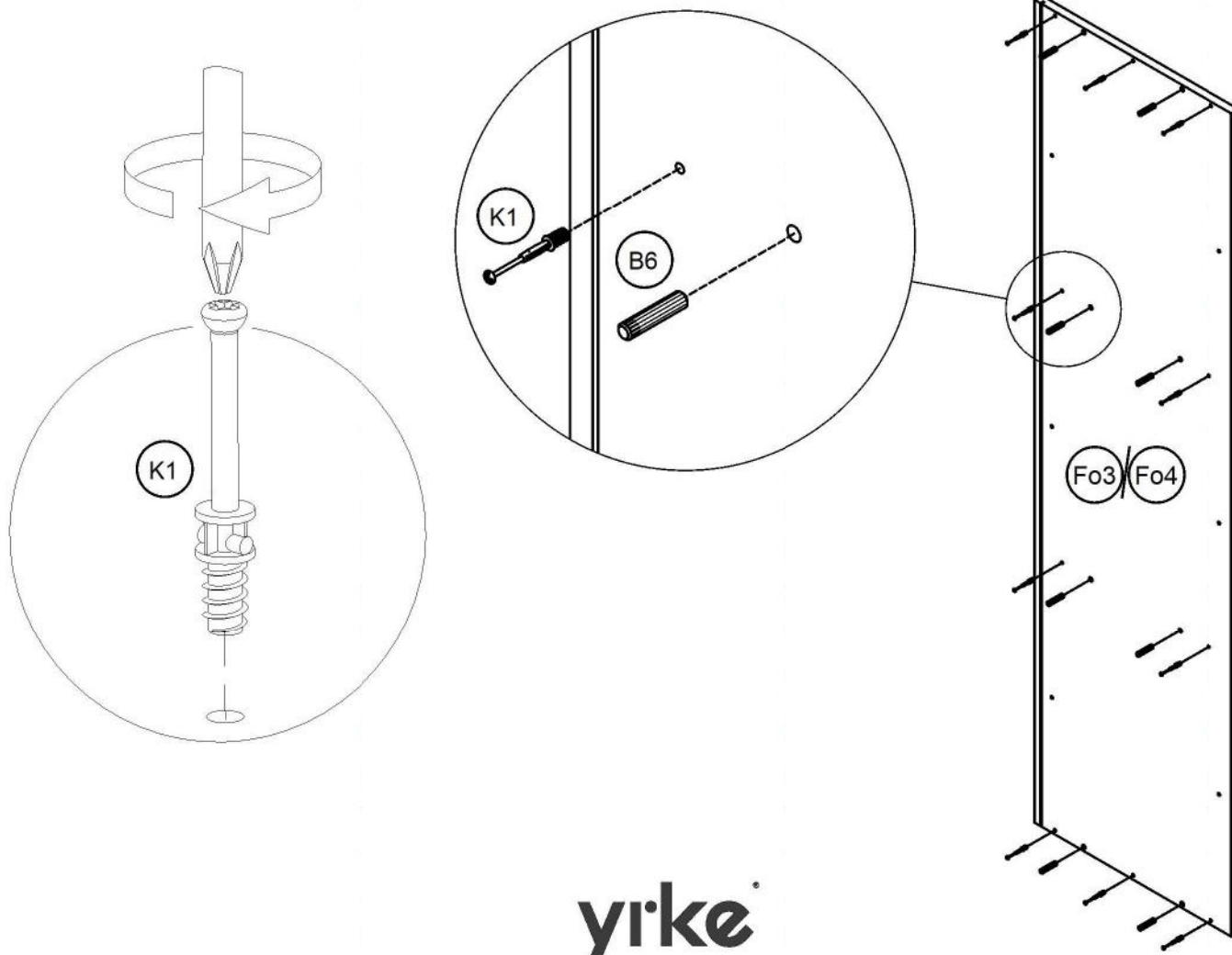

yirke

